

Supports type M4-2

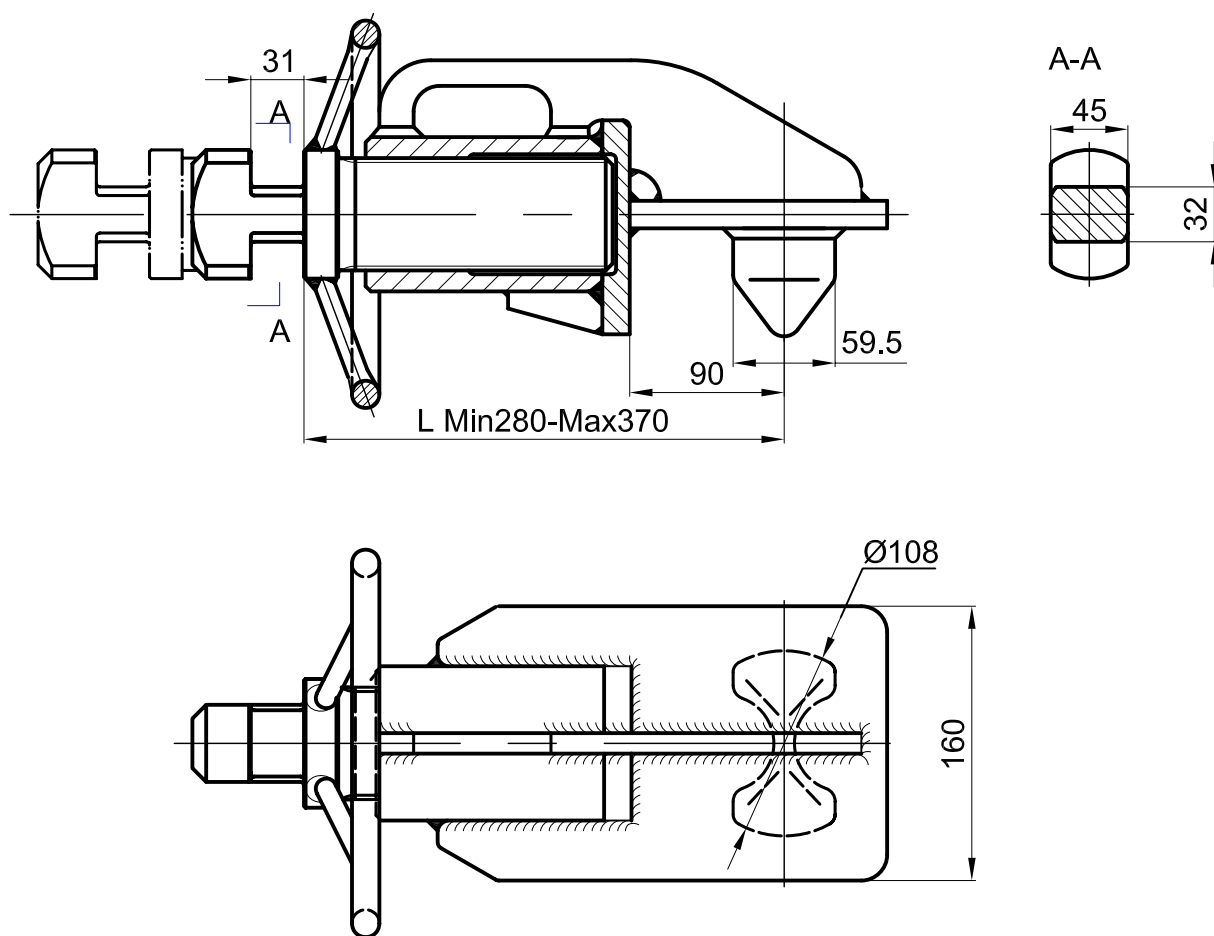

Specifications:

Classification: All items are approved by major classification societies

Materials: Structural steel

Finish: Primer

Remark: Other dimensions, materials and finish upon request

MODEL NO.	B.L.	WEIGHT
M4-2	420kN	19KG