

Spreader type LA-40

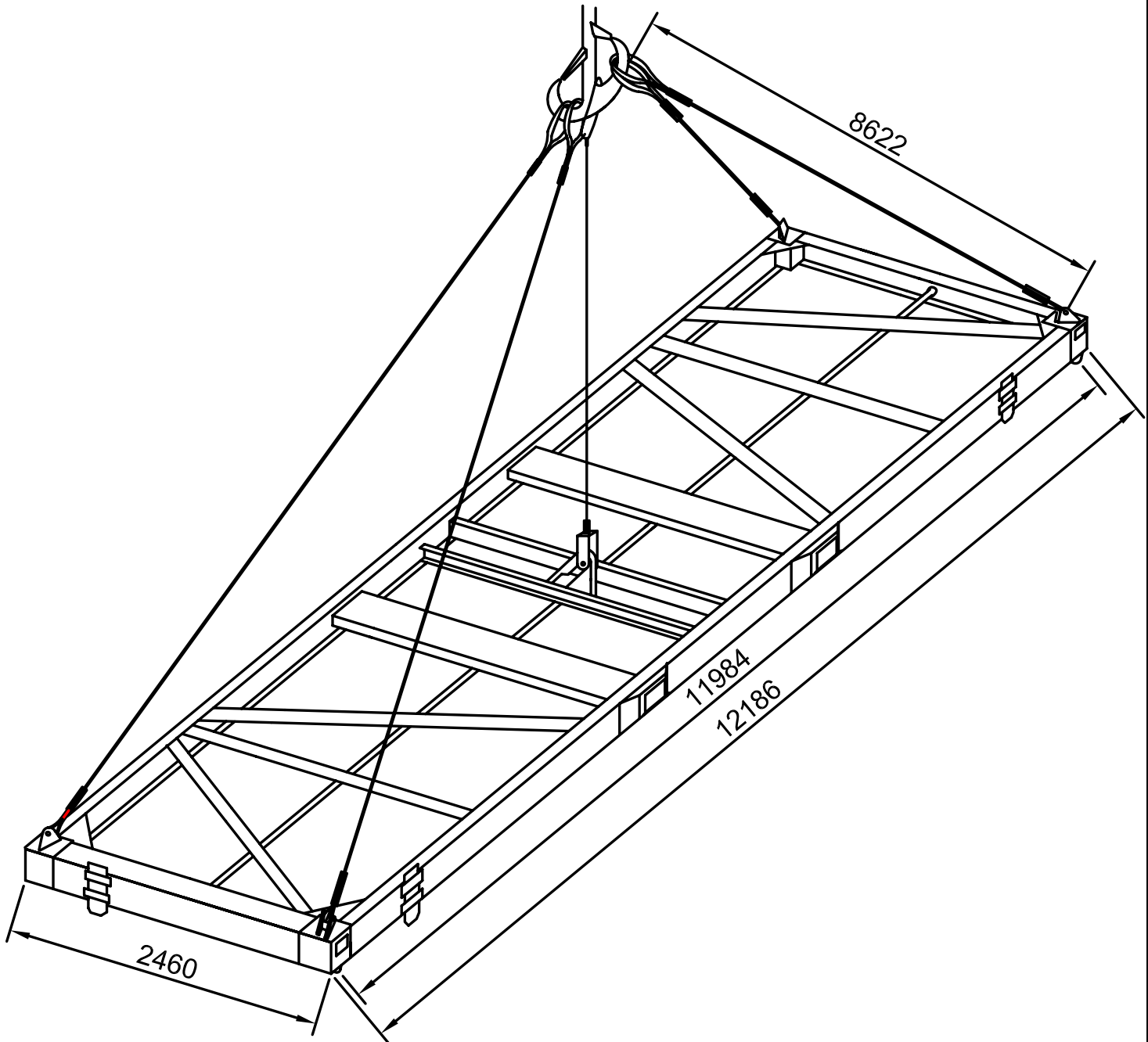

Specifications:

Classification: All items are approved by major classification societies

Materials: Forged & structural steel

Finish: Primer

Remark: Other dimensions, materials and finish upon request

MODEL NO.	S.W.L	WEIGHT
LA-40	42T	